

Technische Daten / Technical Data

- hergestellt aus hochwertigem Stahl
- made of high quality steel
- Oberfläche verzinkt
- tin plated

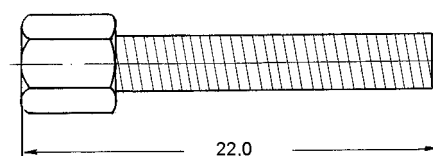
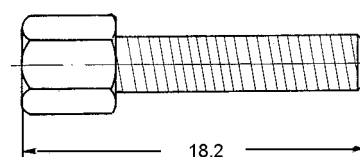
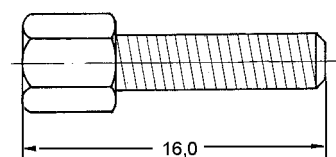
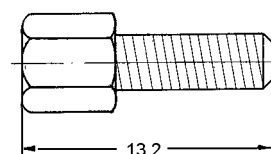
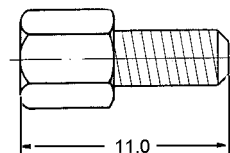
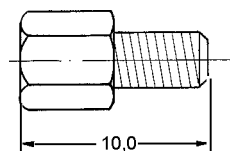
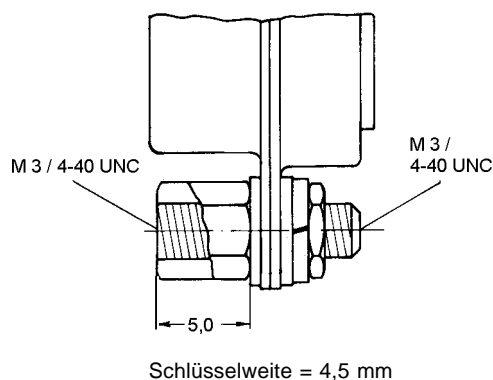

Bestellnummer / Order No.				
Länge / Length	Gewinde (Thread) innen / außen (internal / external)			
	UNC 4-40	M3	UNC 4-40/M3	M3/UNC 4-40
10,00	363-100-U4	363-100-M3	363-100-U4-M3	363-100-M3-U4
11,00	363-110-U4	363-110-M3	363-110-U4-M3	363-110-M3-U4
13,20	363-132-U4	363-132-M3	363-132-U4-M3	363-132-M3-U4
16,00	363-160-U4	363-160-M3	363-160-U4-M3	363-160-M3-U4
18,20	363-182-U4	363-182-M3	363-182-U4-M3	363-182-M3-U4
22,00	363-220-U4	363-220-M3	363-220-U4-M3	363-220-M3-U4

Series and Order No.*

363 — 110 — U4 — M3 — 0

lt. Tabelle
see table

Options*

0 = SK-Gewindeschraube einzeln (Schüttgut)
single screw (bulk goods)

1 = Set als Schüttgut bestehend aus :

packed set as bulk goods includes:

1x Schraube, 1x Mutter, 1x Federring, 2x Distanzscheibe
1x screw, 1x nut, 1x spring washer, 2x distance screw

2 = Set einzeln verpackt mit Zubehör für 1 Stecker:

packed set with accessoires for 1 connector:

2x Schraube, 2x Mutter, 2x Federring, 4x Distanzscheibe
2x screw, 2x nut, 2x spring washer, 4x distance screw

(* Bestellbeispiel - Bitte durch Ihre Spezifikationen ersetzen.

* Order example - To be replaced by your specifications.)

TEL.: +49 5223 98507-0
FAX : +49 5223 98507-50

W+P PRODUCTS

E-MAIL: sales@wpro.com
INTERNET: www.wpro.com