

D-SUB Steckverbinder, Wire Wrap Anschluss D-SUB Connectors, Wire Wrap Version

Technische Daten / Technical Data

Gehäuse	Stahl vernickelt, verzinkt
Shell	Steel, tin coated over nickel
Isolierkörper	Thermoplastischer Kunststoff, nach UL94 V-0
Insulator	Thermoplastic, rated UL94 V-0
Kontaktmaterial	Kupferlegierung
Contact Material	Copper alloy
Kontaktoberfläche	Gold über Nickel
Contact Surface	Gold over nickel
Durchgangswiderstand	< 20mΩ
Contact Resistance	< 20mΩ
Isolationswiderstand	> 1000MΩ
Insulation Resistance	> 1000MΩ
Spannungsfestigkeit	1kV _{AC}
Test Voltage	1kV _{AC}
Nennstrom	5A
Current Rating	5A
Temperaturbereich	-55°C ... +125°C
Temperature Range	-55°C ... +125°C



© W+P PRODUCTS

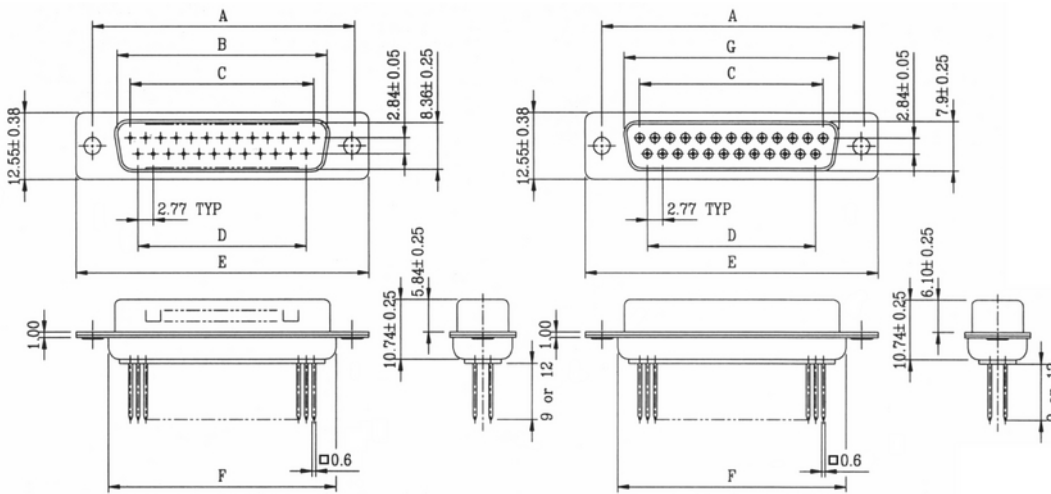

n	A	B	C	D	E	F	G
09	24,99	16,92	11,08	8,31	30,89	19,28	16,33
15	33,32	25,25	19,39	16,62	39,10	27,51	24,66
25	47,04	38,96	33,24	30,47	53,09	41,30	38,38
37	63,50	55,25	49,86	47,09	69,40	57,71	54,84

Series	Contacts*	Terminal Type*	Contact Length*	Quality Class*	Mounting*
300	09 09/15/25/37	1 1 Stift Male 2 Buchse Female	10 10 9,0mm 20 12,0mm	3 GK 1 >500 Steckzyklen Quality class 1: 500 cycles min. GK 2 >200 Steckzyklen Quality class 2: 200 cycles min. GK 3 >50 Steckzyklen Quality class 3: 50 cycles min.	00 0 ... CL Lt. Tech. Info. See Tech. Info.

* Dies ist ein **Bestellbeispiel** - bitte durch Ihre Spezifikationen ersetzen.
* This is an **order example** - please replace by your specifications.

Befestigungsoptionen Mounting Options

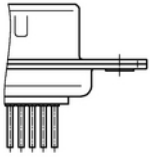

0 Durchgangsloch 3,05mm
3.05mm Through Hole

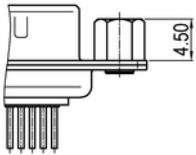

B1 Gewindeniet UNC 4-40
UNC 4-40 Thread Rivet

B2 Gewindeniet M3
M3 Thread Rivet

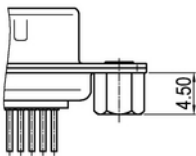

1 Gewindeniet UNC 4-40
UNC 4-40 Thread Rivet

2 Gewindeniet M3
M3 Thread Rivet

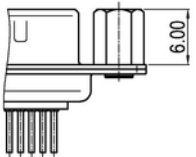

3 Gewindebolzen UNC 4-40
UNC 4-40 Thread Bolt

4 Gewindeniet M3
M3 Thread Rivet

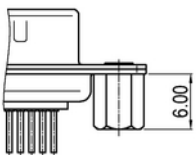

5 Gewindebolzen UNC 4-40
UNC 4-40 Thread Bolt

6 Gewindebolzen M3
M3 Thread Bolt

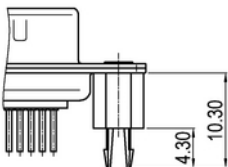

BL Board Lock mit UNC 4-40 Gewinde
Board Lock with UNC 4-40 Thread

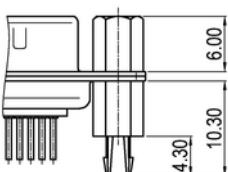

CL Combi-Lock mit UNC 4-40 Gewinde
Combi Lock with UNC 4-40 Thread